

INSTALLATION INSTRUCTIONS FOR OPTIMA SENSOR ACTIVATED LAVATORY FAUCETS WITH THE OPTIMA CONTROL BOX

DECK MOUNTED OPTIMA FAUCETS



ETF-600 Low-height, hardwired
EBF-650 Low-height, battery

ETF-610 Low-height, hardwired
EBF-615 Low-height, battery

ETF-660 Low-height, hardwire with side sensor
EBF-665 Low-height, battery w/side sensor

ETF-80 Mid-height, hardwired
EBF-85 Mid-height, battery

ETF-880 Mid-height, hardwired
EBF-187 Mid-height, battery

GOOSENECK DECK MOUNTED OPTIMA FAUCETS



ETF-770 Hardwired with side sensor
EBF-775 Battery with side sensor

ETF-700 Hardwired
EBF-750 Battery

ETF-700-S Hardwired with surgical bend
EBF-750-S Battery with surgical bend

WALL MOUNTED OPTIMA FAUCETS



ETF-500 Hardwired
EBF-550 Battery

ETF-500-S Hardwired with surgical bend
EBF-550-S Battery with surgical bend

ETF-800 Hardwired
EBF-850 Battery

CONTROL BOX FOR ALL FAUCETS



Control Box w/o Turbine
EFP-39-A



Control Box w/ 0.5 gpm Turbine
EFP-40-A



Control Box w/1.5 gpm Turbine
EFP-11-A

TABLE OF CONTENTS

• Prior To Install.....	2.	• Deck Mounted Rough-in	4.
• Mixing Valve Installation	2.	• Wall Mounted Rough-in.....	5.
• Important	2.	• Dimensional Data	5.
• Quick Connect Tee.....	2.	• Troubleshooting Instructions	7.
• Tools Required.....	2.	• Care and Cleaning Instructions.....	8.

LIMITED WARRANTY

Unless otherwise noted, Sloan Valve Company warrants this product, manufactured and sold for commercial or industrial uses, to be free from defects in material and workmanship for a period of three (3) years (1 year for SF faucets, special finish and PWT electronics and 30 days on PWT software) from date of first purchase. During this period, Sloan Valve Company will, at its option, repair, replace, or refund the purchase price of any product which fails to conform with this warranty under normal use and service. This shall be the sole and exclusive remedy under this warranty. Products must be returned to Sloan Valve Company, at customer's cost. No claims will be allowed for labor, transportation or other costs. This warranty extends only to persons or organizations who purchase Sloan Valve Company's products directly from Sloan Valve Company for purpose of resale. This warranty does not cover the life of the battery.

THERE ARE NO WARRANTIES WHICH EXTEND BEYOND THE DESCRIPTION ON THE FACE HEREOF. IN NO EVENT IS SLOAN VALVE COMPANY RESPONSIBLE FOR ANY CONSEQUENTIAL DAMAGES OF ANY MEASURE WHATSOEVER.

PRIOR TO INSTALLATION

Prior to installing the Sloan Optima Faucet, install the items listed below. Also, refer to rough-in illustrations on pages 4 and 5.

- Lavatory/sink
- Drain line
- Hot and cold water supply lines or pre-tempered water supply line

MIXING VALVE

When installing the faucet with a Sloan mixing valve, these Installation Instructions AND the Installation Instructions packaged with the mixing valve **MUST** be followed.

IMPORTANT

- **ALL PLUMBING SHOULD BE INSTALLED IN ACCORDANCE WITH APPLICABLE CODES AND REGULATIONS.**
- **FLUSH ALL WATER LINES PRIOR TO MAKING CONNECTIONS.**
- **KEEP THREAD SEALANT OUT OF YOUR WATERWAY TO PREVENT COMPONENT PART DAMAGE! DO NOT USE ANY SEALANT ON COMPRESSION FITTINGS.**

QUICK CONNECT BAK CHEK® FILTER TEE USAGE

A QUICK CONNECT BAK-CHEK® FILTER TEE MUST BE USED WITH EACH INSTALLATION.

When connecting a Sloan Optima Faucet to both hot and cold water supplies, a two inlet Quick Connect Bak-Chek® Filter Tee is provided and required as illustrated. Water temperature can be controlled by adjusting the supply stops. When connecting the faucet to a single line water supply or a pre-tempered water supply, a single inlet Quick Connect Bak-Chek® Filter Tee must be used. A Quick Connect Bak-Chek® Filter Tee must also be used when a Temperature Mixing Valve is included with the faucet.

TOOLS REQUIRED FOR INSTALLATION

Gather the required tools and parts before starting installation. Additional parts may be required, depending on your installation. Check local codes. Check existing electrical supply.

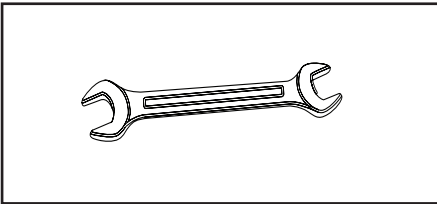

1. Open end wrenches for hex sizes: 1/2", 9/16", 5/8", 15/16"

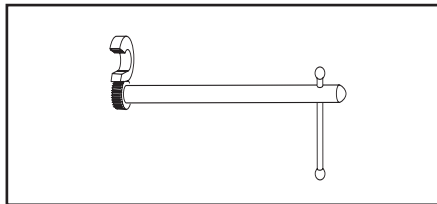

2. Basin wrench

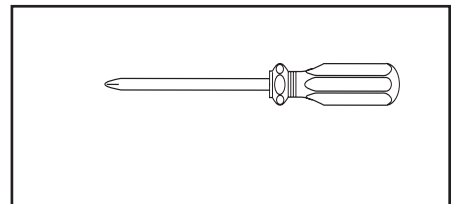

3. Phillips head screwdriver, #2

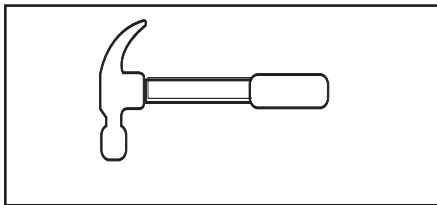

4. Hammer (if installing plastic or hollow wall anchors to mount valve module)

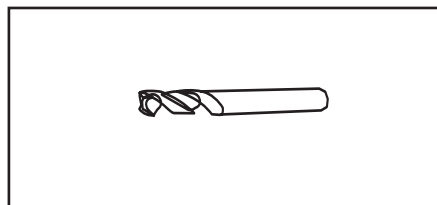

5. 1/4" drill bit (if plastic wall anchors are used to mount valve module)

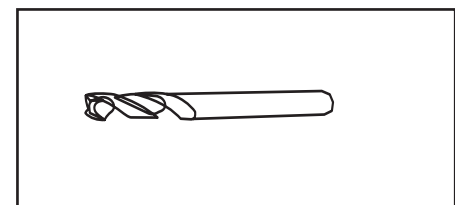

6. 5/16" drill bit (if hollow wall anchors are used to mount valve module)

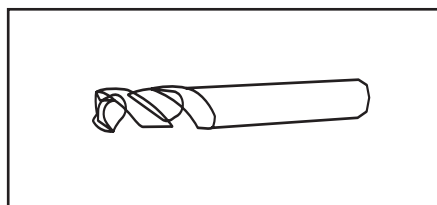

7. 3/8" drill bit (if toggle nut anchors are used to mount valve module)

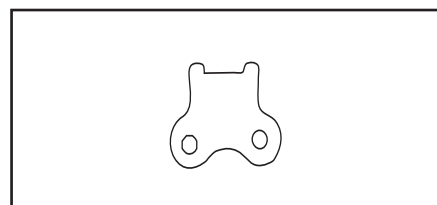

8. Spray head key (supplied with some models)

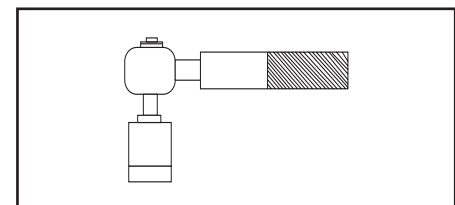

9. 13 mm Socket

MANIFOLD INSTALLATION

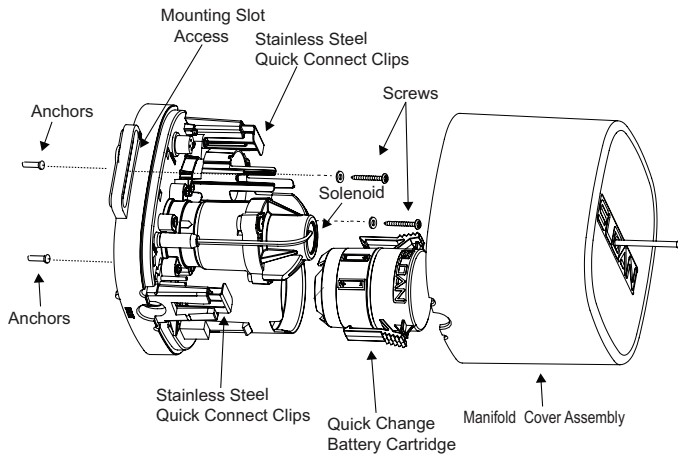

- A.** Ensure there is enough clearance for the flexible supply hose from the spout to connect to the control module
 - B.** Secure control module to wall using the included mounting accessories. The control module must be mounted on a level vertical surface with the Sloan logo on the manifold facing outwards on the top right side of the manifold. Do not mount the manifold in any other position.
 - C.** Insert the flexible supply hose from the bottom of the spout into the top of the mounted manifold. Insert the Filter "T" fitting into the bottom of the mounted manifold. Ensure that the stainless steel clips on both the top and bottom of the manifold are secured.
- NOTE: NEVER OPEN STAINLESS STEEL CLIPS WHEN WATER SUPPLY IS TURNED ON.**

NOTE: FOR UNITS WITH TURBINES, USE ONLY 0.5GPM / 1.9 LPM CONTROL BOXES WITH SPOUTS RATED FOR THE SAME FLOW AND USE ONLY 1.5 GPM / 5.7 LPM CONTROL BOXES WITH SPOUTS RATED FOR THAT SAME FLOW. DO NOT USE THESE CONTROL BOXES ON ANY OTHER FLOW RATES. CONTROL BOXES WITHOUT TURBINES MAY BE USED WITH ANY SPOUT UP TO 2.2 GPM / 8.3 LPM

- D.** Connect water supply lines from the stops to the Filter "T" fitting. If a mixing valve is being used, connect water supply lines to the mixing valve. Connect the mixing valve to the single inlet filter tee using the supplied fitting.
- E.** Attach sensor cable and solenoid cable to the appropriate connections on the manifold.
- F.** Insert the battery assembly.
- G.** This unit can use 4 (AA) batteries alone, or accept 6 VDC or 24 VAC power to function as a hardwired unit with battery back up.
- H.** If a 6 VDC plug-in transformer is used, plug it into the appropriate connection on the manifold to convert the faucet into a "plug-in with battery back-up".
- I.** If 24 VAC hardwires are being used, use the supplied adapter piece to connect the wires to the appropriate connection on the manifold.
- J.** If the unit contains an optional turbine, connect the plug from the turbine assembly into the appropriate connection on the manifold.
- K.** If ganging multiple units in a "daisy chain" configuration to a single power supply use the SFP35 gang adapter kit.
- L.** Inspect and tighten all connections. Place the manifold cover onto the unit.
- M.** Turn on water.

BELOW DECK CONFIGURATION

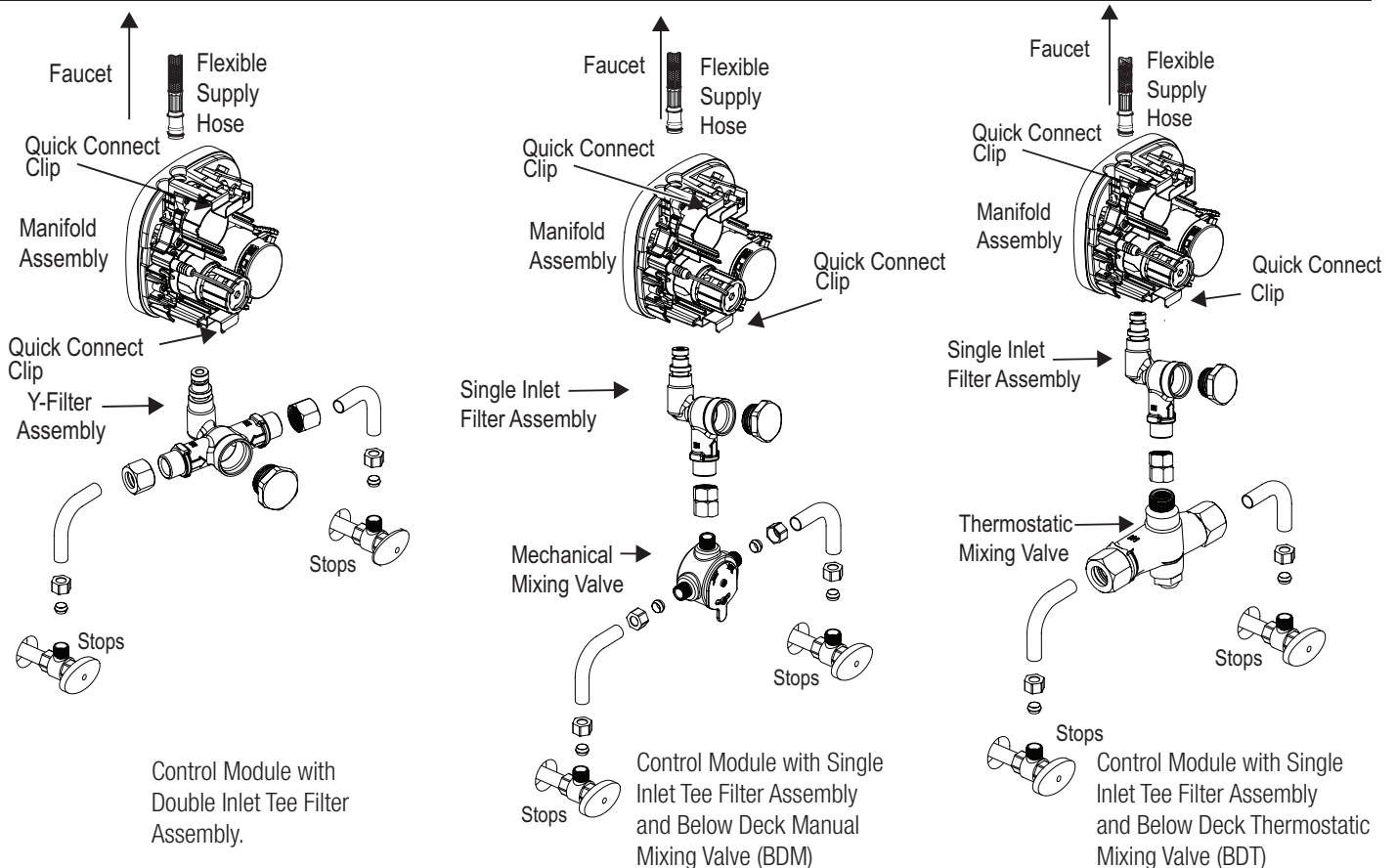

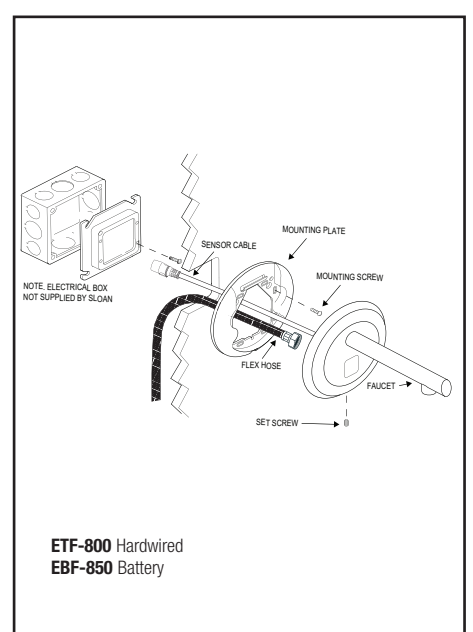
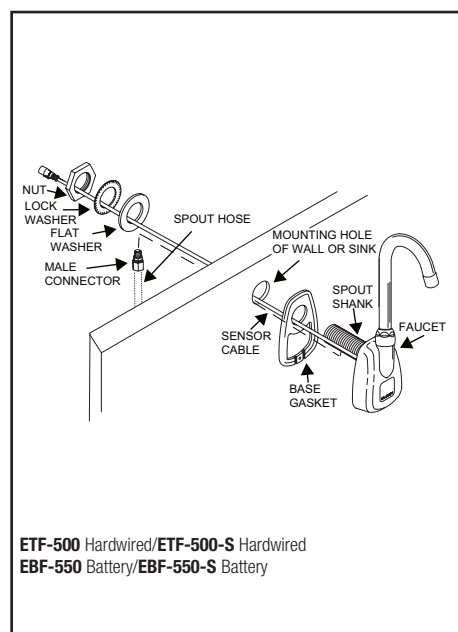
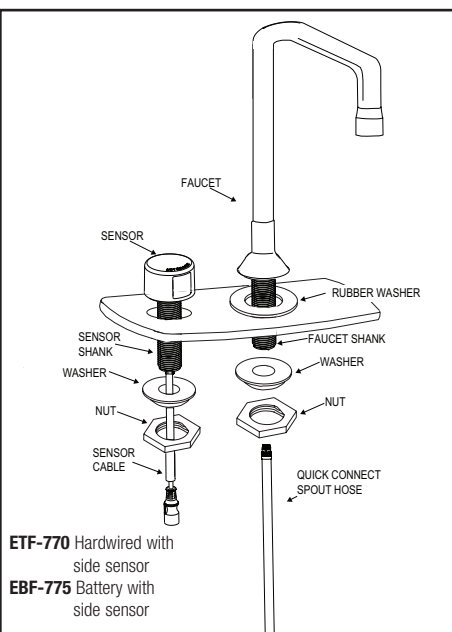
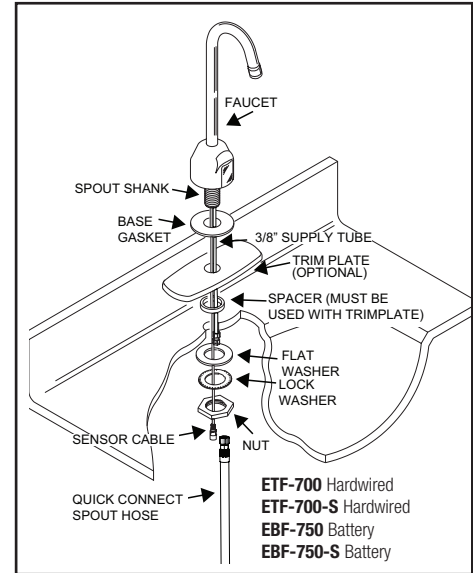
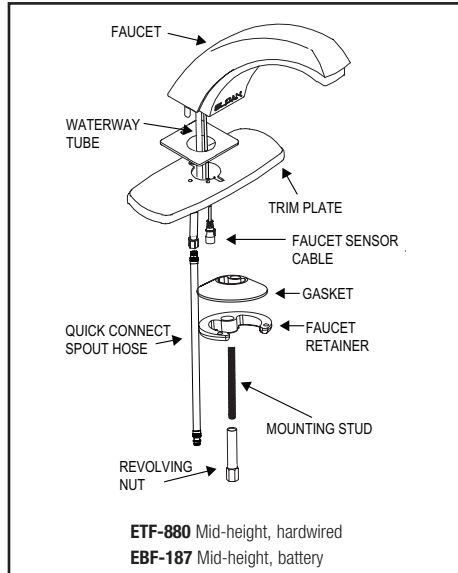
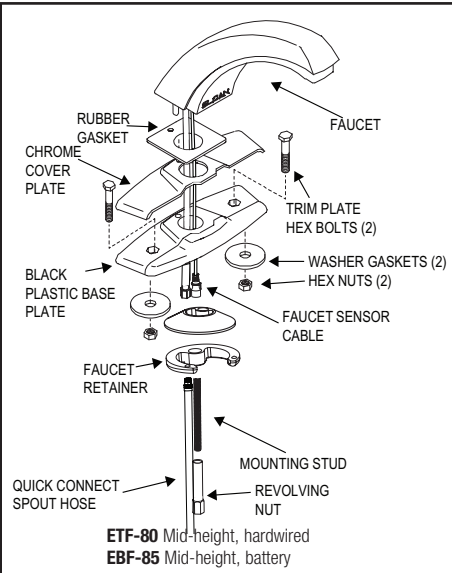
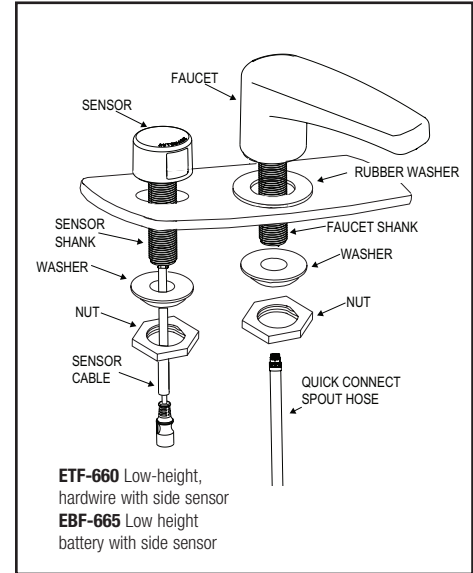
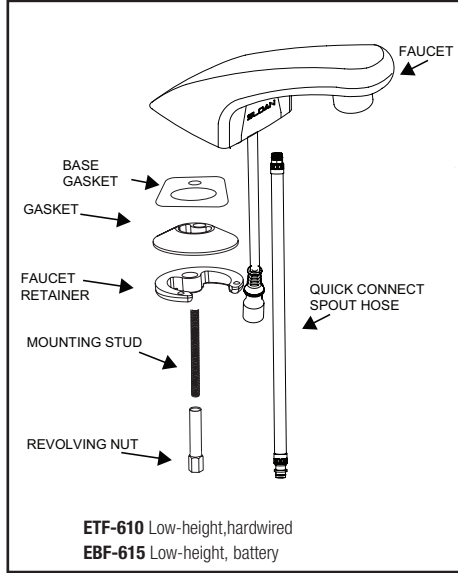
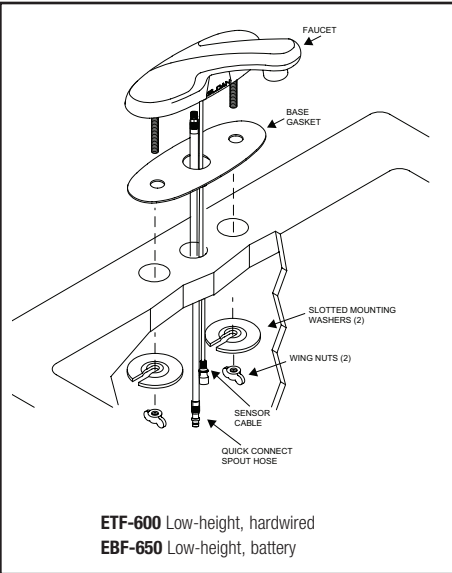

DECK MOUNTED INSTALLATIONS

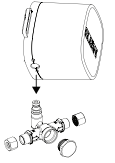
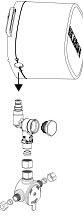
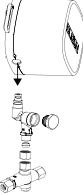

BELOW DECK CONTROL ROUGH-IN DIMENSIONS

OPTIMA CONTROL BOX	MODEL IMAGE	HEIGHT	WIDTH	DEPTH
OPTIMA CONTROL BOX		5" (127 mm)	6" (163 mm)	4 1/2" (115 mm)
OPTIMA CONTROL BOX WITH DOUBLE INLET FILTER TEE		6 1/4" (159 mm)	6" (153 mm)	4 1/2" (115 mm)
OPTIMA CONTROL BOX WITH SINGLE INLET FILTER TEE AND BDM (MIX60)		10 1/8" (258 mm)	6" (153 mm)	4 1/2" (115 mm)
OPTIMA CONTROL BOX WITH SINGLE INLET FILTER TEE AND BDT (MIX135)		10 3/4" (274 mm)	6" (153 mm)	4 1/2" (115 mm)

QUICK CONNECT HOSE/SENSOR CABLE LENGTHS

	QUICK CONNECT SPOUT HOSE LENGTH	SENSOR CABLE LENGTH
		
DECK MOUNTED MODELS	24" (610 mm)	28" (711 mm)
WALL MOUNTED MODELS	36" (914 mm)	36" (914 mm)

DECK MOUNTED FAUCET MODEL ROUGH-IN DIMENSIONS (WITHOUT TRIMPLATE)

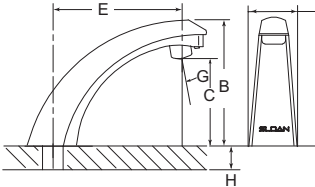
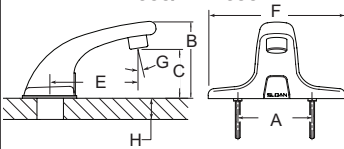
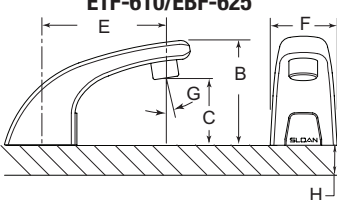
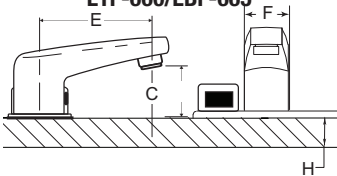
FAUCET MODEL	A	B	C	D	E	F	G	H
	MOUNTING	HEIGHT 1 (DECK TO TOP OF SPOUT)	HEIGHT 1 (DECK TO CENTER OF SPRAYHEAD)	PROJECTION 1 (CENTERLINE OF FAUCET TO END OF SPOUT)	PROJECTION 2 (CENTERLINE OF FAUCET TO CENTER OF SPRAYHEAD)	WIDTH (OF FAUCET)	SPRAY ANGLE (DEGREES)	MAX. DECK THICKNESS
ETF-80/EBF-85 ETF-880/EBF-187 	Single Hole	5 3/4" (146 mm)	4 1/4" (108 mm)	6 1/2" (165 mm)	5 1/8" (130 mm)	2" (51 mm)	12°	1 1/2" (38 mm)
ETF-600/EBF-650 	4" Centerset	3 5/8" (92 mm)	2 3/16" (56 mm)	4 1/2" (114 mm)	4 1/2" (114 mm)	6 5/16" (160 mm)	12°	3/4" (19 mm)
ETF-610/EBF-625 	Single	3 1/2" (89 mm)	2 1/12" (64 mm)	4 1/2" (114 mm)	4 1/2" (114 mm)	2 3/16" (56 mm)	12°	3/4" (19 mm)
ETF-660/EBF-665 	4" Centerset	3 3/4" (95 mm)	2 1/4" (57 mm)	5 1/4" (133 mm)	5 1/4" (133 mm)	1 1/2" (38 mm)	6°	3/4" (19 mm)

GOOSENECK DECK MOUNTED / WALL MOUNTED FAUCET MODEL ROUGH-IN DIMENSIONS WITHOUT TRIMPLATE

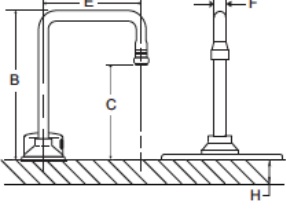
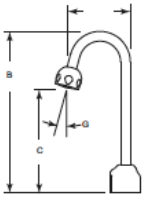
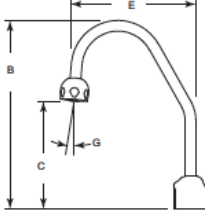
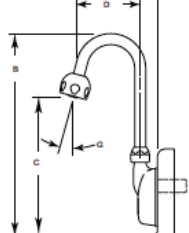
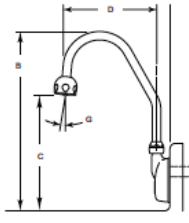
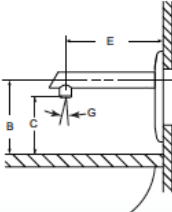
	A	B	C	D	E	F	G	H
FAUCET MODEL	MOUNTING	HEIGHT 1 (DECK TO TOP OF SPOUT)	HEIGHT 1 (DECK TO CENTER OF SPRAYHEAD)	PROJECTION 1 (CENTERLINE OF FAUCET TO END OF SPOUT)	PROJECTION 2 (CENTERLINE OF FAUCET TO CENTER OF SPRAYHEAD)	WIDTH (OF FAUCET)	SPRAY ANGLE (DEGREES)	MAX. DECK THICKNESS
ETF-770 EBF-775 	4" Centerset	9-3/4" (248 mm)	5-1/2" (140 mm)	6-1/8" (156 mm)	5-1/2" (140 mm)	1" (25 mm)	0°	1-1/2" (38 mm)
ETF-700 / EBF-750 	Single Hole	10-1/4" (260 mm)	6-1/4" (159 mm)	5-1/4" (133 mm)	4-1/2" (115 mm)	0.5" (13 mm)	15°	1-1/2" (38 mm)
ETF-700-S / EBF-750-S 	Single Hole	12-1/4" (311 mm)	6-7/8" (175 mm)	9-1/2" (241 mm)	8-7/16" (215 mm)	0.5" (13 mm)	5°	1-1/2" (38 mm)
ETF-500 / EBF-550 	1" (25 mm) Diameter Hole Required	N/A	6-1/8" (156 mm)	4-9/16" (116 mm)	4-1/4" (108 mm)	0.5" (13 mm)	15°	N/A
ETF-500-S / EBF-550-S 	1" (25 mm) Diameter Hole Required	N/A	6-3/4" (171 mm)	8-3/16" (208 mm)	7-1/8" (156 mm)	0.5" (13 mm)	5°	N/A
ETF-800 / EBF-850 	4" Electrical Box & Plaster Ring or 2 1/2" Hole for Mounting bracket	N/A	6-23/32" (170 mm)	6" (152 mm)	7-1/8" (156 mm)	1" (25 mm)	0°	N/A

TROUBLESHOOTING INSTRUCTIONS

NOTE: To automatically check battery strength, troubleshoot, diagnose and report faucet issues with a wireless device, use the Sloan SmartPhone APP. The APP is available free-of-charge at the Apple iPhone APP store for iOS devices or the Google Play APP store for Android devices. For more information about the APP and its capabilities please visit www.Sloan.com.

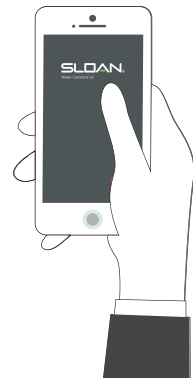

LED indicator light in the IR (infrared) sensor is red.

A. Battery power is low.

Install four (4) new AA sized alkaline batteries. Check that the orientation of each battery matches the positive (+) and negative (-) symbols shown in the bottom of the battery compartment.

Re-attach battery compartment to control module. Green LED will illuminate. If the Green LED does not illuminate, remove battery compartment for 10 seconds and return into place.

Faucet DOES NOT function.

A. Batteries not installed or are exhausted.

Install four (4) AA sized alkaline batteries. Check that the orientation of each battery matches the positive (+) and negative (-) symbols shown in the bottom of the battery compartment. Reattach battery compartment to control module. Green LED will illuminate. If the Green LED does not illuminate, remove battery compartment for 10 seconds and return into place.

B. Power Cable not installed (Hardwire models).

Install power cable and check connection.

C. Sensor Cable not installed.

Install sensor cable and check connection. Confirm connection guide markings are aligned.

D. Sensor range is set too short and is not detecting the target.

Increase sensor detection range.

Sensor is activated but faucet DOES NOT deliver water.

A. Faucet has initiated its adaptive sensing calibration program.

Wait 60 seconds before activating faucet.

B. Solenoid Cable not connected.

Check solenoid cable connection. Confirm connection guide markings are aligned.

Sensor Range Requires Manual Adjustment.

Sensor Range is measured in units from 1 to 5, with 1 being closest to the faucet and 5 being farthest from the faucet. The factory default Sensor Range is 3.

A. To determine what the current Sensor Range setting is, press the red "Sensor" button on the upper right hand corner of the Optima Control Box for 1 second. Five seconds after pressing the button, the green LED beside it will blink to indicate the Sensor Range setting. For example, if it is set at 2, the green LED will blink 2 times.

B. To adjust the Sensor Range, press and hold the red "Sensor" button for three seconds and release once the green LED comes on to indicate that you are in Sensor Range adjustment mode. Then press the "Sensor" button one second at a time for however many times you wish to increase the range. For example, if the Sensor Range is set at 2 and you wish to increase it to 4, press the "Sensor" button two times for one second each time..

C. If you wish to decrease the Sensor Range, follow the same procedure to enter into Sensor Range adjustment mode, and then press the "Sensor" button one second at a time. The button is designed to go up to 5 units and then back down to 1 unit. For example, if the Sensor Range is set at 4 and you wish to decrease it to 2, press the "Sensor" button three times for one second each time.

D. To conform your changes, wait 5 seconds and then press the red "Sensor" button on the upper right hand corner of the Optima Control Box for 1 second. Five seconds after pressing the button, the green LED beside it will blink to indicate the Sensor Range setting. For example, if it is now set at 2, the green LED will blink 2 times.

Solenoid produces an audible "CLICK" when an object is placed in the detection zone of the sensor but NO water flows.

A. Water supply to faucet is not open.

Open supply stop(s).

B. Inlet fitting filter is clogged.

Remove, clean, and reinsert. Replace with EBF1004 solenoid filter kit if necessary.

C. Aerator or spray head is clogged.

Remove, clean, and reinsert.

Solenoid valve DOES NOT produce an audible "CLICK" and NO water flows. Green LED illuminates when batteries installed.

A. Solenoid valve module is not working properly.

Replace EFP43A solenoid valve module.

TROUBLESHOOTING INSTRUCTIONS (CONT.)

Faucet delivers only a slow flow or dribble when sensor is activated.

- A. Water supply valve is partially closed.
Open the supply stop(s) completely.
- B. Inlet fitting filter is clogged.
Remove, clean, and reinsert. Replace with EBF1004 solenoid filter kit if necessary
- C. Aerator or spray head is clogged.
Remove, clean, and reinsert.

Faucet DOES NOT stop delivering water or continues to drip after user is no longer detected (automatic shut-off fails even when batteries are removed).

- A. Solenoid valve seat is dirty.
Remove, clean, and reinsert solenoid filter. Activate faucet several times to flush out dirt.
- B. Sensor range is set too long and is detecting the sink or some other object.
Reduce sensor detection range.
- C. Solenoid valve module is not working properly.
Replace EFP43A solenoid valve module.

The water temperature is too hot or too cold on a faucet connected to hot and cold supply lines with inlet filter fitting.

- A. Supply stops are not adjusted properly.
Adjust supply stops.

NOTE: For some systems, a thermostatic mixing valve may be required

CARE AND CLEANING INSTRUCTIONS

DO NOT USE abrasive or chemical cleaners (including chlorine bleach) to clean faucet that may dull the luster and attack the chrome or special decorative finishes. Use ONLY mild soap and water, then wipe dry with clean cloth or towel. While cleaning the bathroom tile, protect the faucet from any splattering of cleaner. Acids and cleaning fluids will discolor or remove chrome plating.



FCC INFORMATION TO USERS

This equipment has been tested and found to comply with the limits for a class B digital devices, pursuant to Part 15 of the FCC Rules. These limits are designed to provide reasonable protection against harmful interference in a residential installation. This equipment generates, uses, and can radiate radio frequency energy and, if not installed and used in accordance with the instruction manual, may cause harmful interference to radio or television reception, which can be determined by turning the equipment off and on, the user is encouraged to try to correct the interference by one or more of the following measures:

- Reorient or relocate the receiving antenna
- Increase the separation between the equipment and receiver
- Connect the equipment into an outlet on a circuit different from that to which the receiver is connected
- Consult the dealer or an experienced radio/TV technician for help

**If further assistance is required, please contact Sloan Tech Support
at 1-888-SLOAN-14 (1-888-756-2614)**

SLOAN • 10500 SEYMOUR AVENUE • FRANKLIN PARK, IL 60131

Phone: 1-800-982-5839 or 1-847-671-4300 • Fax: 1-800-447-8329 or 1-847-671-4380 • www.sloan.com